



KALCO.
Handcrafted Since 1980

ASSEMBLY & INSTALLATION INSTRUCTIONS

MODEL: 403700
ARLINGTON 3 LIGHT MEDIUM POST MOUNT

IMAGE



If you have any questions or problems assembling your fixture please call us for assistance.

Customer Service: (702) 361-4345 or (800) 525-2655
customer.services@kalco.com

WARNING! TO REDUCE THE RISK OF FIRE OR INJURY PLEASE TAKE PRECAUTION AND FOLLOW THE STEPS BELOW.

1. If you are unfamiliar with electrical wiring, call a qualified electrician to install this unit. More than one person may be necessary to install fixture, make sure you have enough qualified help.
2. Turn off the power to the fixture's circuit at the service panel. Use a voltage detector to verify that the power is off.
3. DO NOT install bulb which exceeds the maximum wattage specified on the socket label.

Si vous avez des questions ou des problèmes assemblage de votre dispositif s'il vous plaît appel pour l'assistance.

Customer Service: (702) 361-4345 or (800) 525-2655
customer.services@kalco.com

AVERTISSEMENT! POUR RÉDUIRE LES RISQUES D'INCENDIE OU DE BLESSURES S'IL VOUS PLAÎT PRENDRE DES PRÉCAUTIONS ET SUIVEZ LES ÉTAPES CI-DESSOUS.

1. Si vous n'êtes pas familier avec le câblage électrique, appelez un électricien qualifié pour installer cet appareil. Plus d'une personne peut être nécessaire d'installer appareil, assurez vous que vous disposez de l'aide assez qualifié.
2. Coupez l'alimentation au circuit de l'appareil sur le tableau de service. Utiliser un détecteur de tension pour vérifier que l'alimentation est coupée
3. NE PAS installer l'ampoule qui excède la puissance maximale indiquée sur l'étiquette du socket.

WIRING DIAGRAM

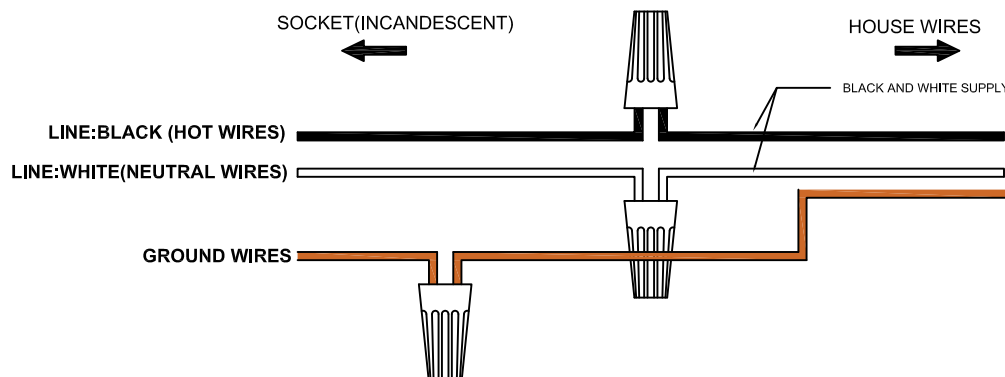



KALCO.
Handcrafted Since 1980

ASSEMBLY & INSTALLATION INSTRUCTIONS

MODEL: 403700
ARLINGTON 3 LIGHT MEDIUM POST MOUNT

COMPONENT ASSEMBLY

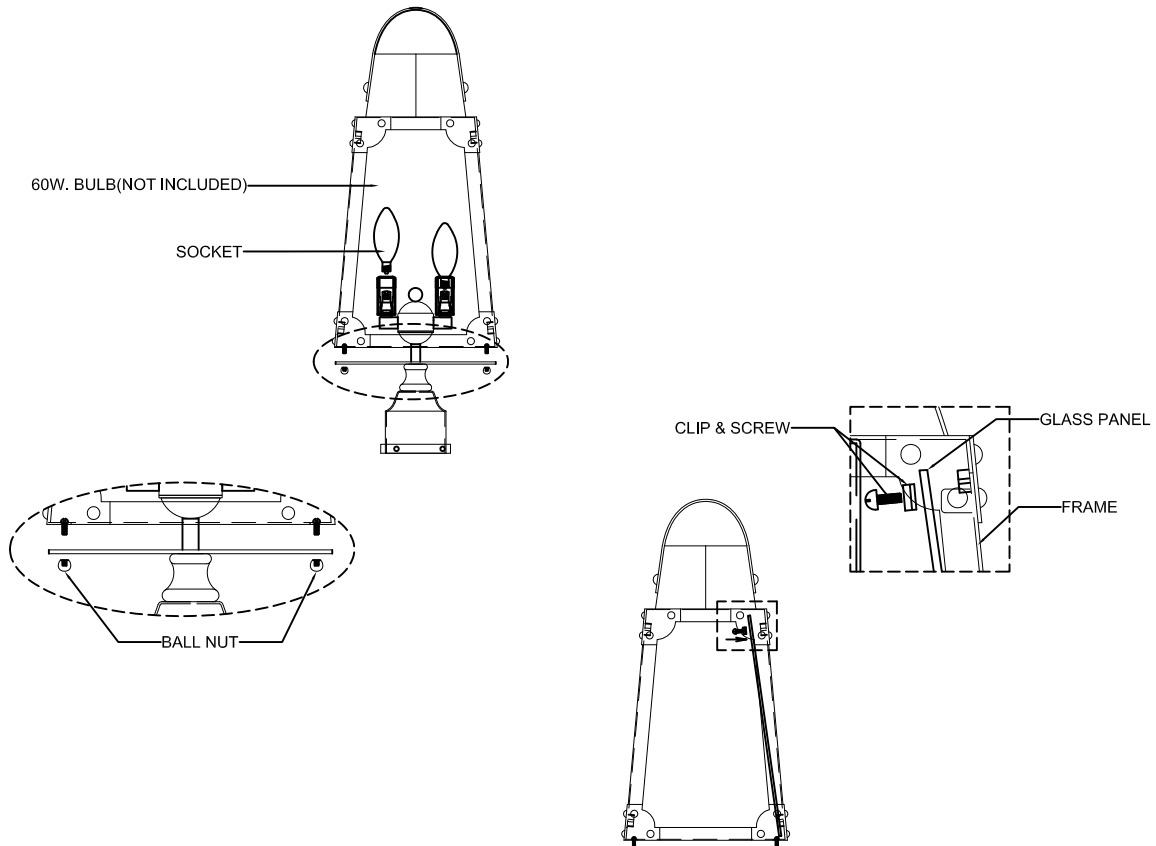

STEP 1: Disassemble item by removing ball nut to the main fixture and drop the glass panel to the glass panel frame secure with bolt and clip provided as shown.

STEP 2: Insert the candle cover to the socket and install bulb, do not use bulbs that exceed 60W, then assemble again.

NOTE :TO AVOID ELECTRIC SHOCK, APPLY WATER SEALANT ON ALL SIDES OF THE FIXTURE MOUNTED ON THE WALL.

LIGHTING MAINTENANCE:

- Regular cleaning of fixture with proper and gentle care using a soft duster, soft lint-free or damp cloth is recommended.
- Refrain from using harsh cleaning liquids that may cause chemical reaction on the hand painted finishes.
- Always refer to the Assembly Instruction before removing any components.
- **HANDLE WITH CARE.**



KALCO
Handcrafted Since 1980

ASSEMBLY & INSTALLATION INSTRUCTIONS

MODEL: 403700
ARLINGTON 3 LIGHT MEDIUM POST MOUNT

ELECTRICAL / MOUNTING INSTALLATION

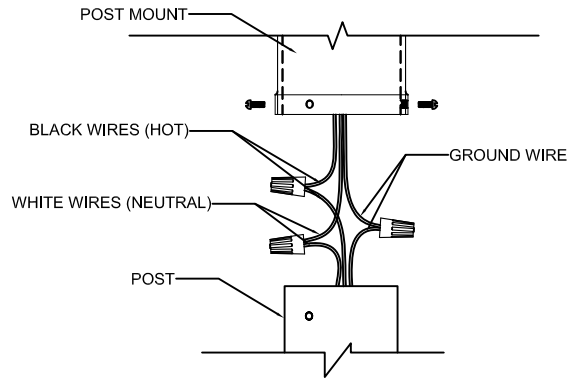

STEP 3: Raise the post mount assembly up to post for wiring. Refer to wiring diagram. With wire carefully threaded thru back plate, connect the black supply wire to the black fixture wire with wire connector, connect the white supply wire to the white fixture wire with wire connector. Connect ground wire from fixture with supply ground wire.

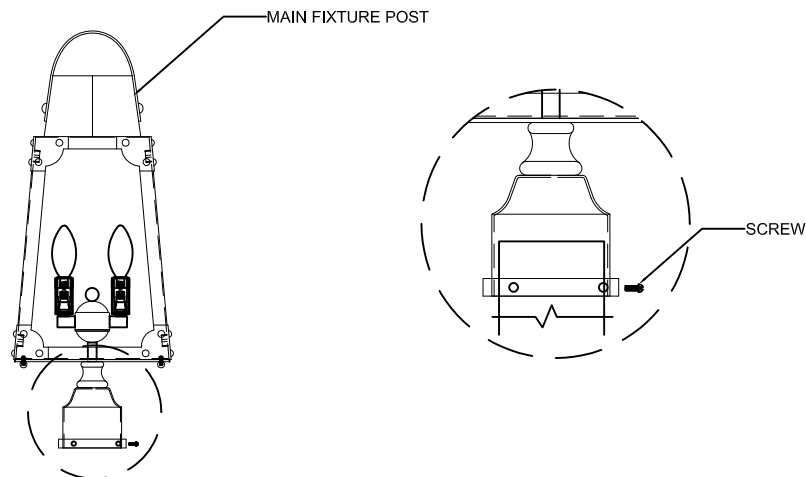

STEP 4: Attach the whole fixture to the stem post after the wiring is done and secure with screws as shown.





KALCO.
Handcrafted Since 1980

ASSEMBLY & INSTALLATION INSTRUCTIONS

MODEL: 403700
ARLINGTON 3 LIGHT MEDIUM POST MOUNT

PARTS LIST

IMAGE	PARTS NAME	QTY
	Screw	2 PCS
	Candle Cover	4 PCS
	Glass Panel	4 PCS